



# MV OLED Control

ALPINE AUTO

OPERATION MANUAL

Ed 1.00

MV Heating UK Ltd  
Unit 6  
3rd Avenue Business Park  
Millbrook  
Southampton  
SO15 0LP



MV Heating UK LTD  
+44 (0)2380 522345



# Contents

OLED Display .....	3
Operation .....	4
Initial Start Up & Standby Mode .....	4
Changing Operation Mode.....	4
Operating Modes .....	5
Variable Output Mode .....	5
Thermostatic Mode.....	6
Fan Only Mode.....	7
Settings.....	8
Changing Language .....	8
Bluetooth .....	9
Sound .....	10
Information Display.....	11
Countdown Timer .....	12
Factory Reset .....	13
Fuel Priming Function .....	13
LED Indicator .....	14
Faults.....	15
No Connection .....	15
Disconnect.....	15
Fault .....	16
	1



Updates .....	16
Installation .....	17
Location.....	17
Installation Steps.....	18
Fault Codes.....	19
Notes .....	20

## OLED Display

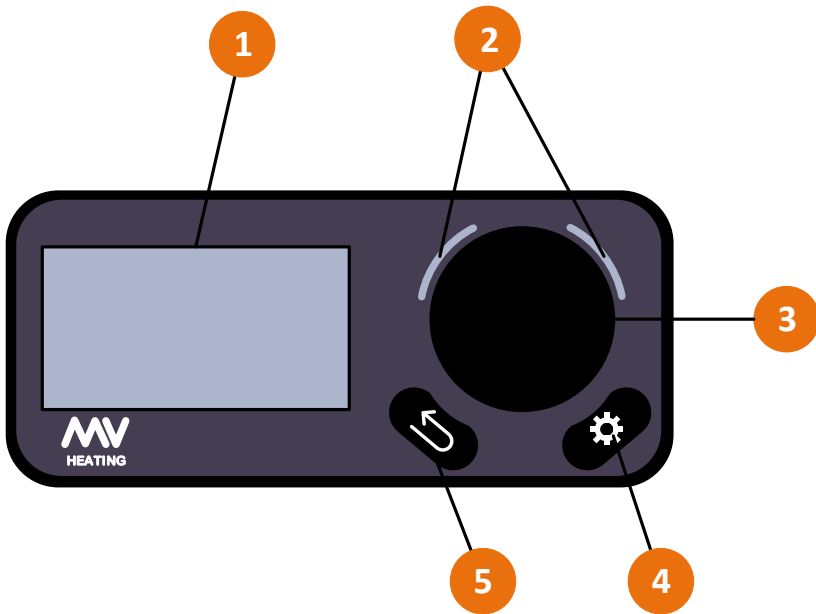

**Figure 1**

1. OLED Display
2. LED Indicators
3. Rotary Knob and Confirm Button
4. Settings Button
5. Return/Back Button

## Operation

### Initial Start Up & Standby Mode



Once the unit has been powered on, the panel will enter an initialization state.



Once this has completed, the panel will enter the normal control interface.

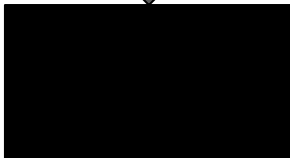

After 30 seconds of inactivity the display will turn blank. This is the standby mode. Press any button to wake the display up.

### Changing Operation Mode



Press the rotary knob to enter the operation select mode. Turn the knob to the left or the right and press it to select the desired mode. When the heater is running, both the variable output, and thermostatic modes can be switched between, but not the fan only mode.

## Operating Modes

### Variable Output Mode

In variable output mode, once turned on the heater will continue to run until it is manually turned off again. Whilst turned on, the rotary knob is used to select the power output (fan speed) of the heater. The higher the fan speed, the greater the volume of hot air will be pushed into the heating space.

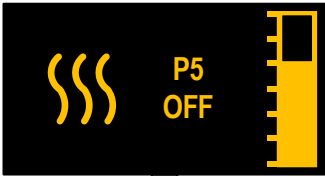
- 

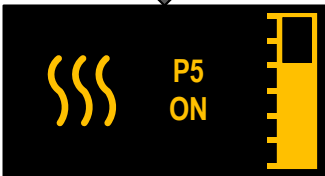
1. Once you've selected the variable output mode, hold the rotary knob for three seconds.
- 

2. The LED indicators will turn green, and the display will change from 'ON' to 'OFF'.
- 

3. Use the rotary knob to change the power output between P1 (lowest) to P7 (highest).

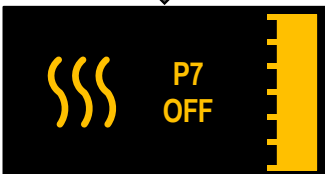

- 

4. Press and hold the rotary knob to switch the heater off. The LED indicators will turn red, and the heater will then run its cool-down cycle for several minutes, before switching off completely.

## Thermostatic Mode



In thermostatic mode, the heater will run until it has reached the set temperature and (version dependent) will either switch off completely or continue to run the fan until the temperature has dropped significantly that the heater will then relight and start again. The unit will continue to cycle until the controller is switched off completely. Temperature will vary depending on where the temperature probe is installed, and how much ambient air flow it has.

- 

1. Once you've selected the thermostatic mode, hold the rotary knob for three seconds.
- 

2. The LED indicators will turn green, and the display will change from 'ON' to 'OFF'.
- 

3. Use the rotary knob to change the temperature between 5°C (lowest) to 35°C (highest).



- 

4. Press and hold the rotary knob to switch the heater off. The LED indicators will turn red, and the heater will then run its cool-down cycle for several minutes, before switching off completely.

## Fan Only Mode

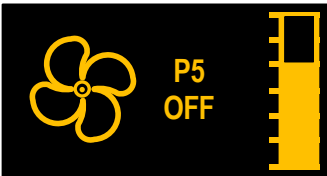
In fan only mode, once turned on the heater will only run the fresh air fan until it is manually turned off again. Whilst turned on, the rotary knob is used to select the fan speed. The higher the fan speed, the greater the volume of air will be pushed into the heating space.

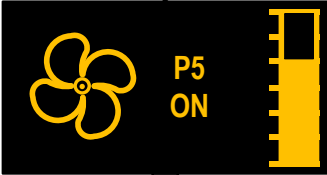
- 

1. Once you've selected the fan only mode, hold the rotary knob for three seconds.
- 

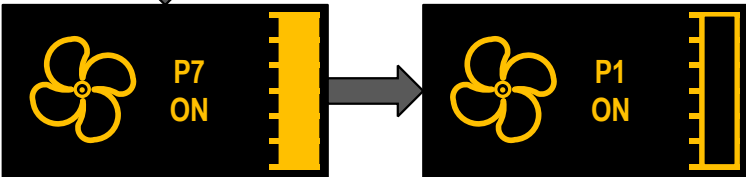
2. The LED indicators will turn green, and the display will change from 'ON' to 'OFF'.
- 

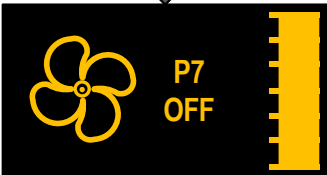
3. Use the rotary knob to change the power output between P1 (lowest) to P7 (highest).
- 

4. Press and hold the rotary knob to switch the heater off.



## Settings

### Changing Language



Enter the setting mode by pressing the settings button.

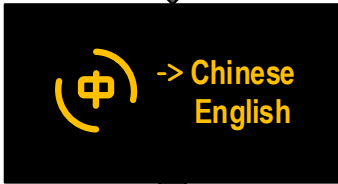

Use the rotary knob to select language. Confirm by pressing the rotary knob once.



Select between Chinese and English by using the rotary knob and pressing to confirm.

Press the return button to go back at any time.

**NOTE:** The language setting has a memory function and will not change when power has been cut off.

## Bluetooth

The Bluetooth function is compatible with the 'Mybluee' app on smart devices. Once connected, please refer to the separate app manual for further information.



Enter the setting mode by pressing the settings button.



Use the rotary knob to select the Bluetooth setting. Confirm by pressing the rotary knob once.

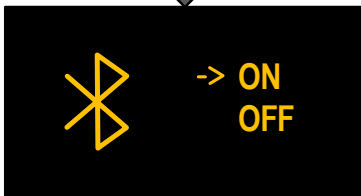

Select between ON and OFF by using the rotary knob and pressing to confirm.

Press the return button to go back at any time.

When turned on, the Bluetooth symbol will appear on the top left on the display.

**NOTE:** The Bluetooth setting has a memory function and will not change when power has been cut off.

## Sound

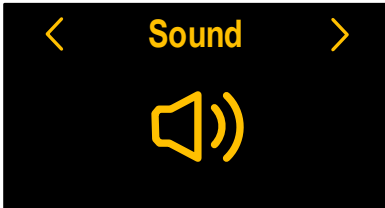

Enter the setting mode by pressing the settings button.

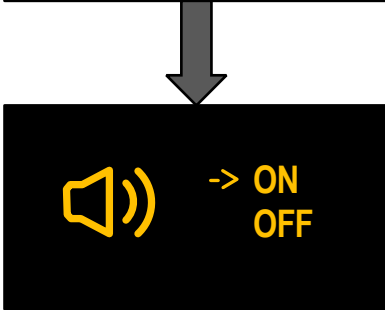

Use the rotary knob to select the sound setting. Confirm by pressing the rotary knob once.

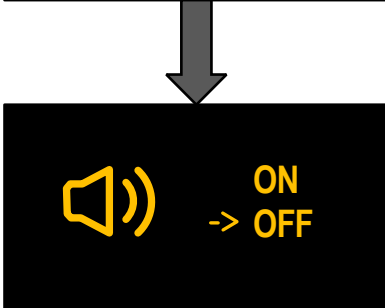

Select between ON and OFF by using the rotary knob and pressing to confirm.

Press the return button to go back at any time.

**NOTE:** The sound setting has a memory function and will not change when power has been cut off.

## Information Display



Enter the setting mode by pressing the settings button.

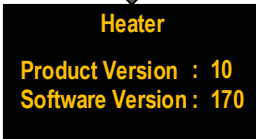

Use the rotary knob to select the information setting. Confirm by pressing the rotary knob once.

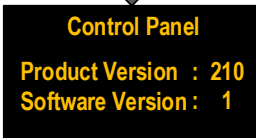

Use the rotary knob to switch between various information on the control panel.

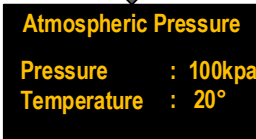

These include heater information, OLED (control) panel information, atmospheric pressure, and the heater's run time, on your current OLED display.

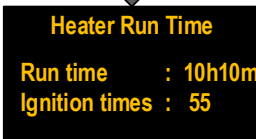

Press the return button to go back at any time.



**NOTE:** The monitoring mode is for professionals.

## Countdown Timer



Enter the setting mode by pressing the settings button and use the rotary knob to select the Countdown Mode. Confirm by pressing the rotary knob once.

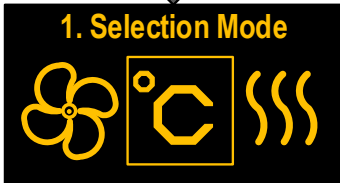

In the selection mode, use the rotary knob to select which mode you would like the heater to run in (see pages 4-6 for more information), and press the rotary knob to confirm.

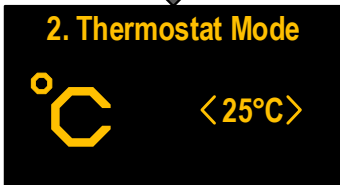

Use the rotary knob to select the temperature (if thermostat mode has previously been selected) or power output (if variable output, or fan only mode have previously been selected). Confirm by pressing the rotary knob.

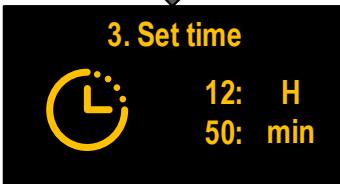

Select the time when you want the heater to start. 12H and 50min means the heater will start in 12 hours, and 50 minutes. It does not refer to how long the heater will run for.

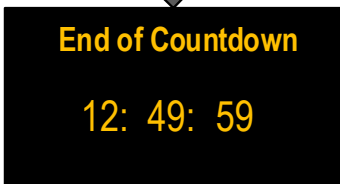

The countdown clock will begin, and the heater will start after the clock has run down.

Press the return button to go back at any time.

## Factory Reset

To reset the panel to the default factory settings, enter the setting mode by pressing the settings button and use the rotary knob to select the factory reset setting. Confirm by pressing the rotary knob once.



The display will read 'Factory Reset?' – Confirm by pressing the rotary knob.

Press the return button to go back at any time.



**NOTE:** Factory reset restores the language, Bluetooth, sound, and other related settings.

## Fuel Priming Function



To enter the fuel priming mode press and hold the rotary knob, and the return button together. When the display reads 'Prime Fuel?' press the rotary knob to confirm. The fuel pump will begin to pulse quickly.



Use the rotary knob to adjust the pumping time and press the return button to go back or let the countdown timer run down (default runtime is 90 seconds). **NOTE:** Disconnect the fuel from the heater first to prevent flooding

## LED Indicator

The LED indicator will flash and/or change colour depending on what state the heater is in.

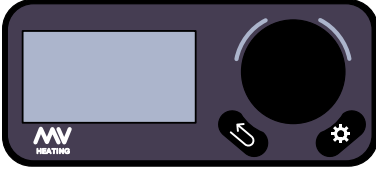

**No Lights:** When the control panel is in use or in standby mode and the heater is not running.

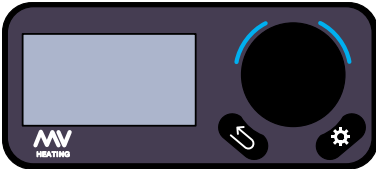

**Blue Lights:** When the control panel is initializing.

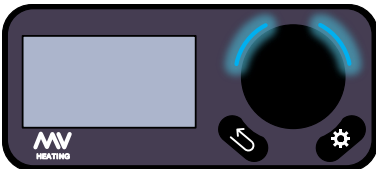

**Blue Lights Flashing:** When the control panel is disconnected.

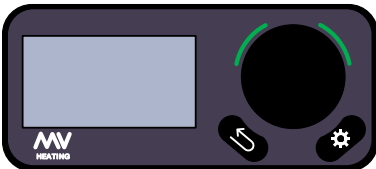

**Green Lights:** When the heater is running.

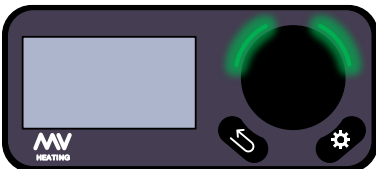

**Green Lights Flashing:** Fault condition - The heater has detected a fault.

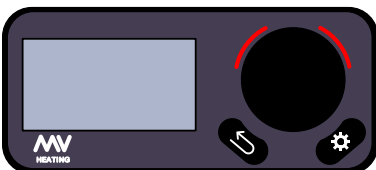

**Red Lights:** When the heater is shutting down.

## Faults

When a fault appears, or the controller has lost connection, a prompt will appear.

### No Connection



When starting the control panel, if the OLED display is unable to initialize, the panel will enter a disconnected state.

Press any key to attempt initializing again. If no connection continues, check the communication cable is installed correctly.

### Disconnect



If the communication between the heater and control panel becomes disconnected during an operation (heater is running, fuel priming etc.) the display will read 'Disconnect'.



If disconnect continues, check the communication cable is installed correctly, and has not become damaged.



## Fault

If the heater detects a fault, the display will go into a fault state.



The display will read the fault code (number) and the fault cause.

To exit the fault display, hold the rotary knob.

**NOTE:** After exiting the fault display, please wait until the heater is completely turned off before restarting the heater. Otherwise, the heater may not exit the lockout state.

## Updates



If connected via Bluetooth to the MyBlue app, any updates to the OLED display or the heater will turn the display into an update state.

The display will automatically exit the update state when the update is complete.

## Installation

**NOTES:** The control switch must be installed in the vehicle in accordance with any corresponding technical specifications for vehicle control.

### Safety Information:

- Find a suitable mounting surface within the vehicle to fix the control switch.
- Do not use high-voltage devices unless the electronic circuit (PCB board) has been disconnected.
- If welding is required on the vehicle, do not connect the DC power supply to the control switch. Welding will cause serious damage to the switch.
- Do not shorten the original control lead wire.
- When installing this control switch, the vehicle power supply must be turned off.
- This control switch should be installed in a waterproof and moisture-proof location.

### Location

The control switch should be installed where it is easy to read and locate. The control panel opening size is 16mm X 22mm, as shown below.

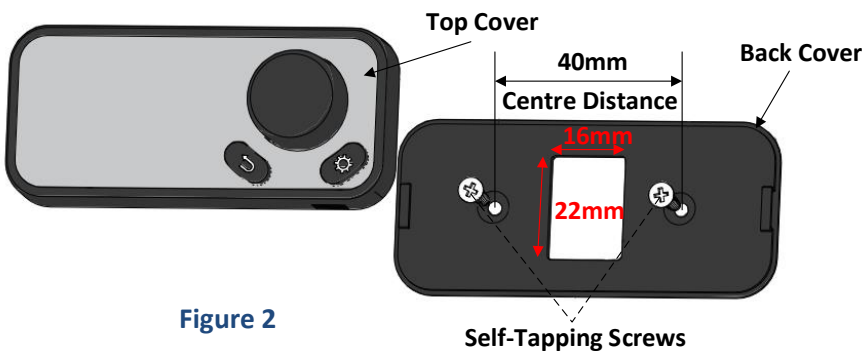

Figure 2

## Installation Steps

1. Clean the installation opening and surface to ensure that it is smooth and clean with no dust or water.
2. Insert the tapping screw into the mounting surface as shown in Figure 2 and fix the back cover on the mounting surface.
3. Insert one end of the control switch lead wire into the PCB board's terminal seat as shown in Figure 3, and the other end through the back cover and installation opening as shown in Figure 2.
4. Finally, press the top cover firmly onto the back cover as shown in Figure 4.

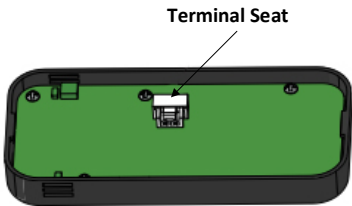

Figure 3

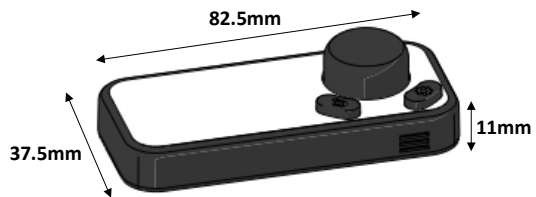

Figure 4

**NOTES:** Do not make any tensile stress on the control switch (communication) wires.

If any of the cables are pulled out during operation, it will cause the heater to interrupt and fail, and may even damage the heater and/or controller.



## Fault Codes

Code on Digital Timer	Error Description	Error Light (Flashing Light) on Rotary Control
00	No Fault	F01
10	Second start failure	
20	Heater does not light in time	F02
21	Combustion termination	
30	Voltage too high	F03
31	Voltage too low	
A9	Voltage too low	
41	Overheated	F10
50	Flame sensor open circuit	F05
51	Flame sensor short circuit	
52	Hot air sensor open circuit	
53	Hot air sensor short circuit	
54	Hot air sensor overheated	
65	Inside temperature sensor broken circuit	F06
66	Inside temperature sensor short circuit	
68	Outside temperature circuit broken circuit	
69	Outside temperature circuit short circuit	
70	Fuel pump short circuit	F07
71	Fuel pump broken circuit	
80	Fan broken circuit	F08
81	Fan short circuit	
82	fan speed too low	
83	Fan speed too high	
84	Fan speed measurement fault	
90	Glow pin open circuit	F09
91	Glow pin short circuit	
92	Glow pin high resistance	
93	Glow plug drive open circuit	
a2	Overheating	F10
b4	Overheating or sensor fault	F11
b5	Overheat sensor fault	
c0	Hydro only - blower relay open circuit	F12
c1	Hydro only - blower relay short circuit	
c4	Preheating temperature broken circuit	
c5	Preheating temperature short circuit	
d0	Crystal oscillator in ECU broken	F13
d1	Fault information storage failure	
d3	Maintenance reminder	
-	Earthing Issue	Constant Flash
-	Connection Issue	Traffic Light



## Notes

.....

.....

.....

.....

.....

.....

.....

.....

.....

.....

.....