



MV OLED Control

ALPINE AUTO

OPERATION MANUAL

Ed 1.01

MV Heating UK Ltd
Unit 6
Second Avenue Business Park
Millbrook
Southampton
SO15 0LP



MV Heating UK LTD
+44 (0)2380 522345



Contents

| | |
|---------------------------------------|----|
| OLED Display | 3 |
| Operation | 4 |
| Initial Start Up & Standby Mode | 4 |
| Changing Operation Mode..... | 4 |
| Operating Modes | 5 |
| Variable Output Mode | 5 |
| Thermostatic Mode..... | 6 |
| Fan Only Mode..... | 7 |
| Settings..... | 8 |
| Changing Language | 8 |
| Bluetooth | 9 |
| Sound | 10 |
| Information Display..... | 11 |
| Countdown Timer | 12 |
| Fuel Priming Function | 13 |
| Factory Reset | 14 |
| LED Indicator | 15 |
| Faults..... | 16 |
| No Connection | 16 |
| Disconnect..... | 16 |
| Fault | 17 |
| | 1 |

+44 (0)23 8052 2345



| | |
|-------------------------|----|
| Updates | 17 |
| Installation | 18 |
| Location..... | 18 |
| Installation Steps..... | 19 |
| Fault Codes..... | 20 |
| Notes | 21 |

OLED Display

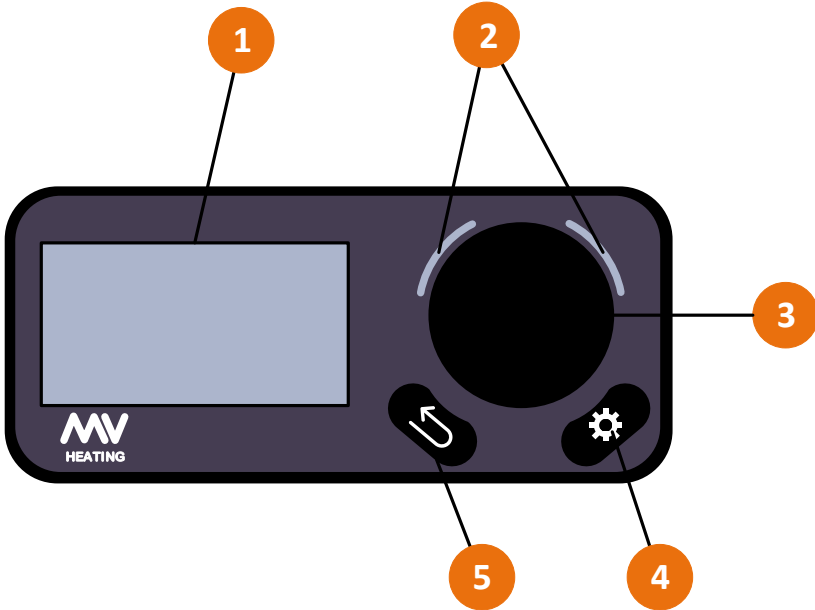

Figure 1

1. OLED Display
2. LED Indicators
3. Rotary Knob and Confirm Button
4. Settings Button
5. Return/Back Button

Operation

Initial Start Up & Standby Mode



Once the unit has been powered on, the panel will enter an initialization state.

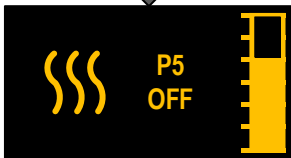

Once this has completed, the panel will enter the normal control interface.

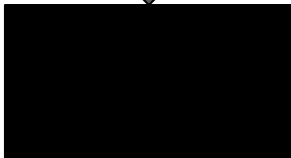

After 30 seconds of inactivity the display will turn blank. This is the standby mode. Press any button to wake the display up.

Changing Operation Mode



Press the rotary knob to enter the operation select mode. Turn the knob to the left or the right and press it to select the desired mode. When the heater is running, both the variable output, and thermostatic modes can be switched between, but not the fan only mode.

Operating Modes

Variable Output Mode

In variable output mode, once turned on the heater will continue to run until it is manually turned off again. Whilst turned on, the rotary knob is used to select the power output (fan speed) of the heater. The higher the fan speed, the greater the volume of hot air will be pushed into the heating space.

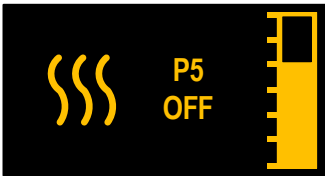
- 

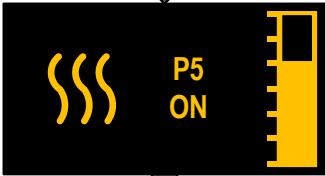
1. Once you've selected the variable output mode, hold the rotary knob for three seconds.
- 

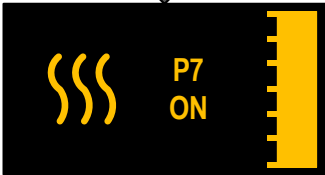
2. The LED indicators will turn green, and the display will change from 'ON' to 'OFF'.
- 

3. Use the rotary knob to change the power output between P1 (lowest) to P7 (highest).

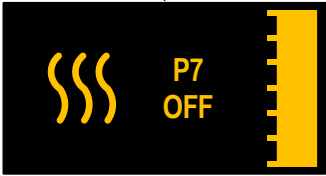
- 

4. Press and hold the rotary knob to switch the heater off. The LED indicators will turn red, and the heater will then run its cool-down cycle for several minutes, before switching off completely.

Thermostatic Mode

In thermostatic mode, the heater will run until it has reached the set temperature and (version dependent) will either switch off completely or continue to run the fan until the temperature has dropped significantly that the heater will then relight and start again. The unit will continue to cycle until the controller is switched off completely. Temperature will vary depending on where the temperature probe is installed, and how much ambient air flow it has.

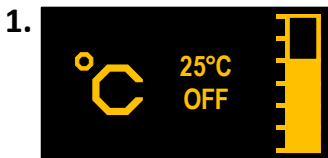

1. Once you've selected the thermostatic mode, hold the rotary knob for three seconds.



2. The LED indicators will turn green, and the display will change from 'ON' to 'OFF'.

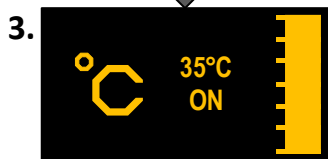

3. Use the rotary knob to change the temperature between 5°C (lowest) to 35°C (highest).

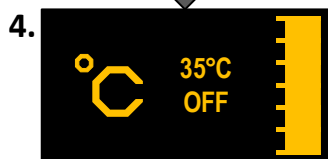

4. Press and hold the rotary knob to switch the heater off. The LED indicators will turn red, and the heater will then run its cool-down cycle for several minutes, before switching off completely.

Fan Only Mode

In fan only mode, once turned on the heater will only run the fresh air fan until it is manually turned off again. Whilst turned on, the rotary knob is used to select the fan speed. The higher the fan speed, the greater the volume of air will be pushed into the heating space.

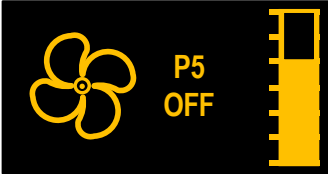
- 

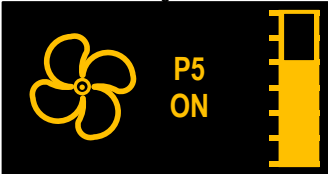
1. Once you've selected the fan only mode, hold the rotary knob for three seconds.
- 

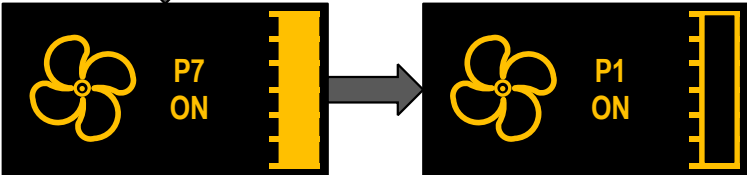
2. The LED indicators will turn green, and the display will change from 'ON' to 'OFF'.
- 

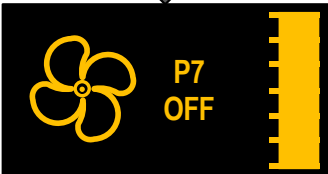
3. Use the rotary knob to change the power output between P1 (lowest) to P7 (highest).
- 

4. Press and hold the rotary knob to switch the heater off.

Settings

Changing Language



Enter the setting mode by pressing the settings button.



Use the rotary knob to select language. Confirm by pressing the rotary knob once.

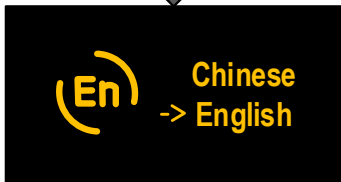

Select between Chinese and English by using the rotary knob and pressing to confirm.

Press the return button to go back at any time.

NOTE: The language setting has a memory function and will not change when power has been cut off.

Bluetooth

The Bluetooth function is compatible with the 'Mybluee' app on smart devices. Once connected, please refer to the separate app manual for further information.



Enter the setting mode by pressing the settings button.



Use the rotary knob to select the Bluetooth setting. Confirm by pressing the rotary knob once.



Select between ON and OFF by using the rotary knob and pressing to confirm.

Press the return button to go back at any time.

When turned on, the Bluetooth symbol will appear on the top left on the display.

NOTE: The Bluetooth setting has a memory function and will not change when power has been cut off.

Sound

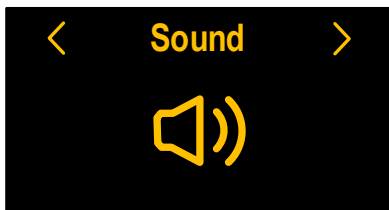

Enter the setting mode by pressing the settings button.

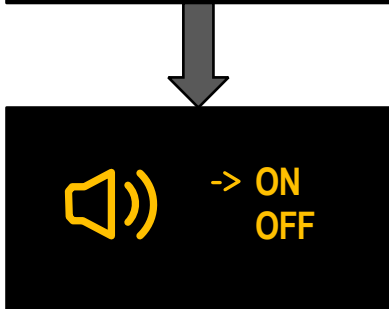

Use the rotary knob to select the sound setting. Confirm by pressing the rotary knob once.

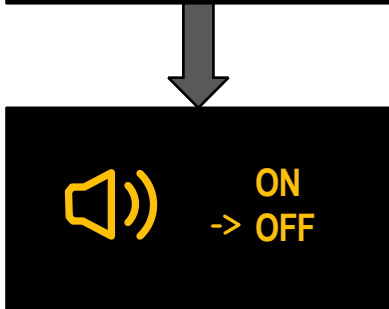

Select between ON and OFF by using the rotary knob and pressing to confirm.

Press the return button to go back at any time.

NOTE: The sound setting has a memory function and will not change when power has been cut off.

Information Display



Enter the setting mode by pressing the settings button.

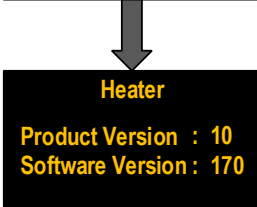

Use the rotary knob to select the information setting. Confirm by pressing the rotary knob once.

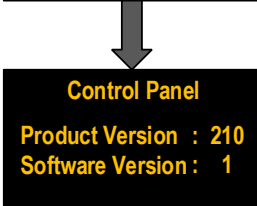

Use the rotary knob to switch between various information on the control panel.

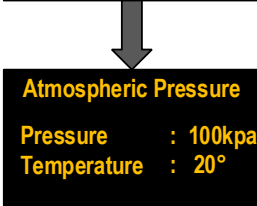

These include heater information, OLED (control) panel information, atmospheric pressure, and the heater's run time, on your current OLED display.

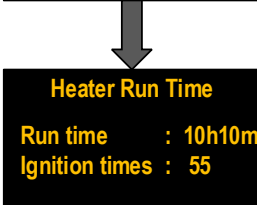

Press the return button to go back at any time.

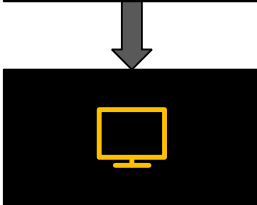

NOTE: The monitoring mode is for professionals.

Countdown Timer



Enter the setting mode by pressing the settings button and use the rotary knob to select the Countdown Mode. Confirm by pressing the rotary knob once.

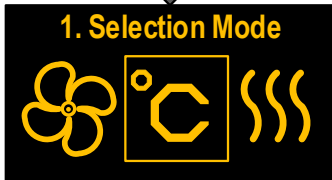

In the selection mode, use the rotary knob to select which mode you would like the heater to run in (see pages 4-6 for more information), and press the rotary knob to confirm.

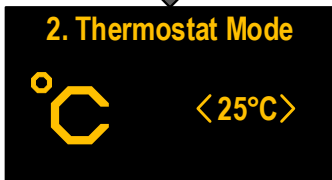

Use the rotary knob to select the temperature (if thermostat mode has previously been selected) or power output (if variable output, or fan only mode have previously been selected). Confirm by pressing the rotary knob.

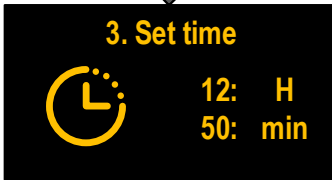

Select the time when you want the heater to start. 12H and 50min means the heater will start in 12 hours, and 50 minutes. It does not refer to how long the heater will run for.

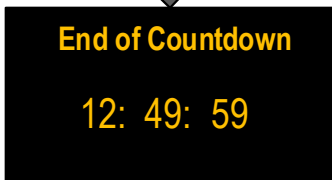

The countdown clock will begin, and the heater will start after the clock has run down.

Press the return button to go back at any time.

Fuel Priming Function



To enter the fuel priming mode, press the settings icon, and scroll to 'Information'. Press the rotary dial to confirm.

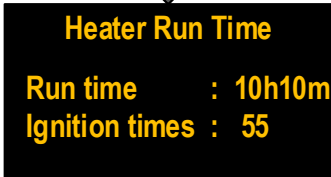

Scroll along to the 'Heater Run Time' submenu and press and hold the settings button, and the return button together.

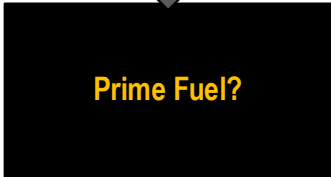

When the display reads 'Prime Fuel?' press the rotary knob to confirm. The fuel pump will begin to pulse quickly.



Use the rotary knob to adjust the pumping time and press the return button to go back or let the countdown timer run down (default runtime is 90 seconds). **NOTE:** Disconnect the fuel from the heater first to prevent flooding

Factory Reset

To reset the panel to the default factory settings, enter the setting mode by pressing the settings button and use the rotary knob to select the factory reset setting. Confirm by pressing the rotary knob once.

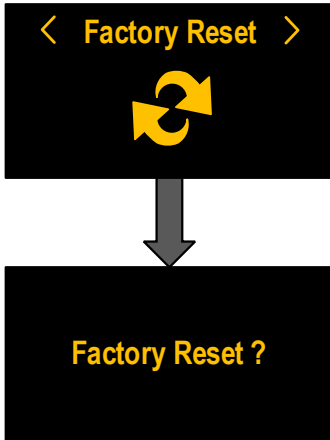

The display will read 'Factory Reset?' – Confirm by pressing the rotary knob.

Press the return button to go back at any time.

NOTE: Factory reset restores the language, Bluetooth, sound, and other related settings.

LED Indicator

The LED indicator will flash and/or change colour depending on what state the heater is in.

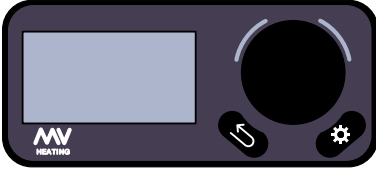

No Lights: When the control panel is in use or in standby mode and the heater is not running.

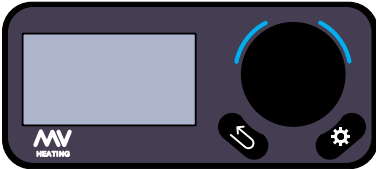

Blue Lights: When the control panel is initializing.

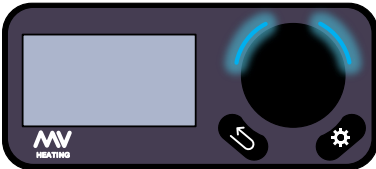

Blue Lights Flashing: When the control panel is disconnected.

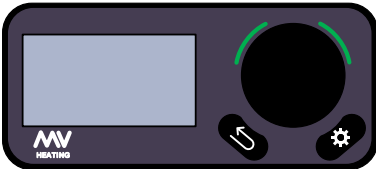

Green Lights: When the heater is running.

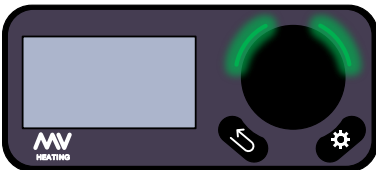

Green Lights Flashing: Fault condition - The heater has detected a fault.

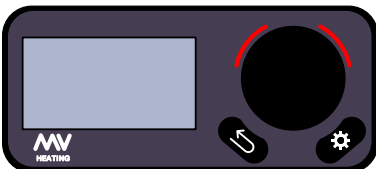

Red Lights: When the heater is shutting down.

Faults

When a fault appears, or the controller has lost connection, a prompt will appear.

No Connection



When starting the control panel, if the OLED display is unable to initialize, the panel will enter a disconnected state.

Press any key to attempt initializing again. If no connection continues, check the communication cable is installed correctly.

Disconnect



If the communication between the heater and control panel becomes disconnected during an operation (heater is running, fuel priming etc.) the display will read 'Disconnect'.



If disconnect continues, check the communication cable is installed correctly, and has not become damaged.

Fault

If the heater detects a fault, the display will go into a fault state.



The display will read the fault code (number) and the fault cause.

To exit the fault display, hold the rotary knob.

NOTE: After exiting the fault display, please wait until the heater is completely turned off before restarting the heater. Otherwise, the heater may not exit the lockout state.

Updates



If connected via Bluetooth to the MyBluee app, any updates to the OLED display or the heater will turn the display into an update state.

The display will automatically exit the update state when the update is complete.

Installation

NOTES: The control switch must be installed in the vehicle in accordance with any corresponding technical specifications for vehicle control.

Safety Information:

- Find a suitable mounting surface within the vehicle to fix the control switch.
- Do not use high-voltage devices unless the electronic circuit (PCB board) has been disconnected.
- If welding is required on the vehicle, do not connect the DC power supply to the control switch. Welding will cause serious damage to the switch.
- Do not shorten the original control lead wire.
- When installing this control switch, the vehicle power supply must be turned off.
- This control switch should be installed in a waterproof and moisture-proof location.

Location

The control switch should be installed where it is easy to read and locate. The control panel opening size is 16mm X 22mm, as shown below.

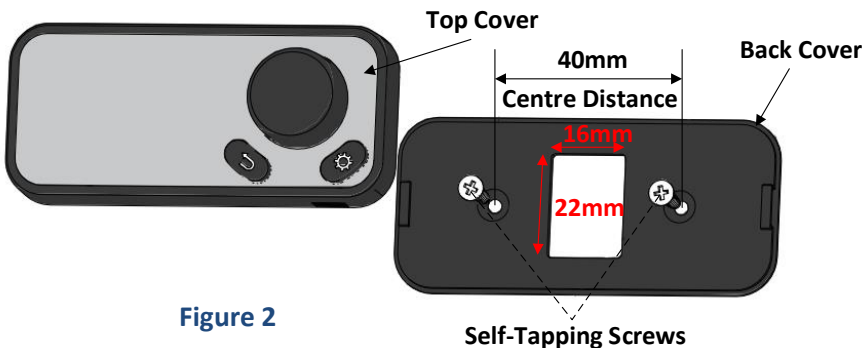

Figure 2

Installation Steps

1. Clean the installation opening and surface to ensure that it is smooth and clean with no dust or water.
2. Insert the tapping screw into the mounting surface as shown in Figure 2 and fix the back cover on the mounting surface.
3. Insert one end of the control switch lead wire into the PCB board's terminal seat as shown in Figure 3, and the other end through the back cover and installation opening as shown in Figure 2.
4. Finally, press the top cover firmly onto the back cover as shown in Figure 4.

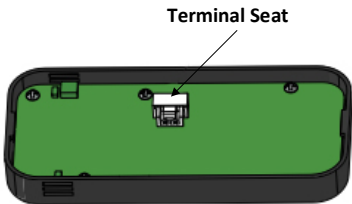

Figure 3

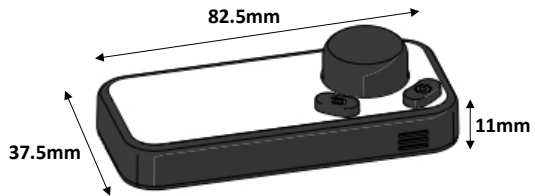

Figure 4

NOTES: Do not make any tensile stress on the control switch (communication) wires.

If any of the cables are pulled out during operation, it will cause the heater to interrupt and fail, and may even damage the heater and/or controller.



Fault Codes

| Code on Digital Timer | Error Description | Error Light (Flashing Light) on Rotary Control |
|-----------------------|--|--|
| 00 | No Fault | F01 |
| 10 | Second start failure | |
| 20 | Heater does not light in time | F02 |
| 21 | Combustion termination | |
| 30 | Voltage too high | F03 |
| 31 | Voltage too low | |
| A9 | Voltage too low | |
| 41 | Overheated | F10 |
| 50 | Flame sensor open circuit | F05 |
| 51 | Flame sensor short circuit | |
| 52 | Hot air sensor open circuit | |
| 53 | Hot air sensor short circuit | |
| 54 | Hot air sensor overheated | |
| 65 | Inside temperature sensor broken circuit | F06 |
| 66 | Inside temperature sensor short circuit | |
| 68 | Outside temperature circuit broken circuit | |
| 69 | Outside temperature circuit short circuit | |
| 70 | Fuel pump short circuit | F07 |
| 71 | Fuel pump broken circuit | |
| 80 | Fan broken circuit | F08 |
| 81 | Fan short circuit | |
| 82 | fan speed too low | |
| 83 | Fan speed too high | |
| 84 | Fan speed measurement fault | |
| 90 | Glow pin open circuit | F09 |
| 91 | Glow pin short circuit | |
| 92 | Glow pin high resistance | |
| 93 | Glow plug drive open circuit | |
| a2 | Overheating | F10 |
| b4 | Overheating or sensor fault | F11 |
| b5 | Overheat sensor fault | |
| c0 | Hydro only - blower relay open circuit | F12 |
| c1 | Hydro only - blower relay short circuit | |
| c4 | Preheating temperature broken circuit | |
| c5 | Preheating temperature short circuit | |
| d0 | Crystal oscillator in ECU broken | F13 |
| d1 | Fault information storage failure | |
| d3 | Maintenance reminder | |
| - | Earthing Issue | Constant Flash |
| - | Connection Issue | Traffic Light |



Notes

.....

.....

.....

.....

.....

.....

.....

.....

.....

.....

.....